

High-pressure coolant holder series

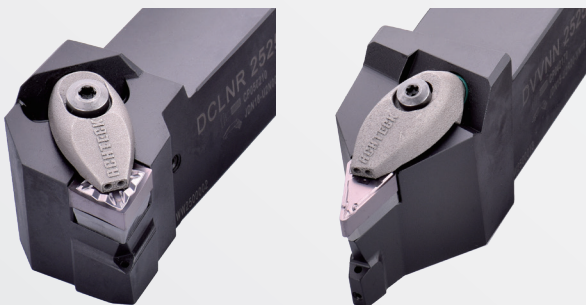

Product portfolio included external turning holder, grooving and cut-off holder as well as related coolant accessory. It also can achieve good chip control and tool life improvement even if low pressure coolant.

Ext. Turning Holder



Grooving and Cut-off Holder

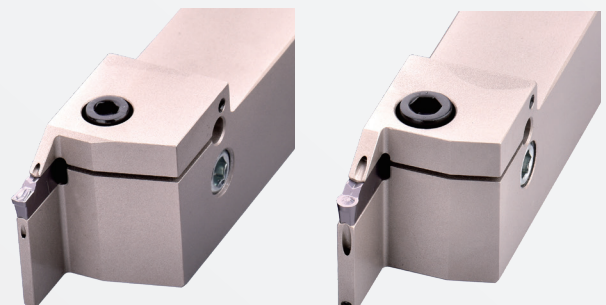

Ext. HP Coolant Holder

With accurate HP coolant technology, can achieve excellent chip control and better tool life in HRSA and Titanium machining.

Particular structural design

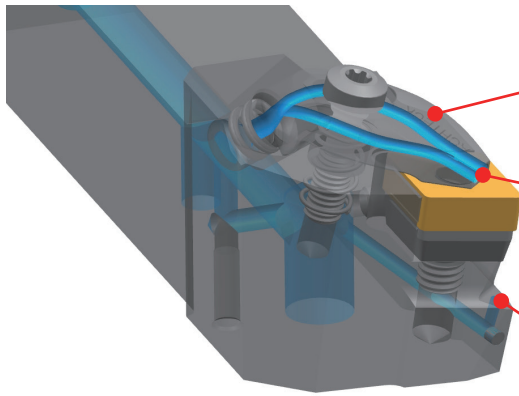

① 3D printing clamp with fluid dynamics design

Better conformable clamping, accurate jet cooling to achieve excellent chip control

② Dual clamping structure

Coolant nozzles point to cutting zone as close as possible, can significant reduce cutting temperature meanwhile achieve high clamping force and simple inserts exchange.

③ Coolant nozzle in clearance face

Reduce cutting temperature with sufficient coolant flow

Ext. Turning Holder Portfolio

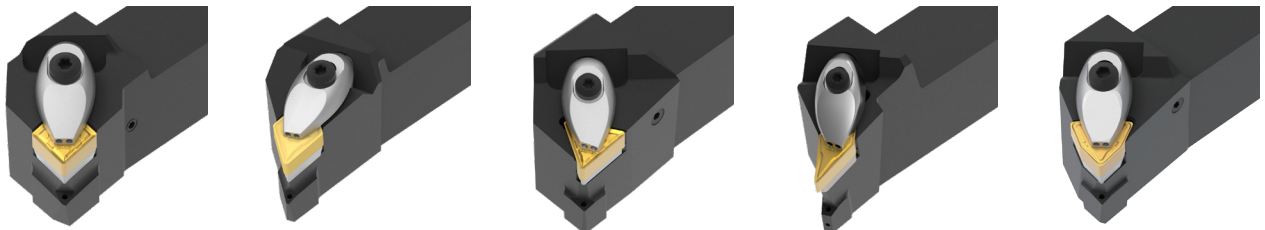

Chip-breaking comparison

HP Int. Coolant (7MPa)



Ext. Coolant (0.4MPa)



Cutting parameters: $V_c=280$ m/min, $f=0.26$ mm/rev, $a_p=1.5$ mm Wet
Material: 4140#
Insert type: CNMG120408

Wear resistance comparison

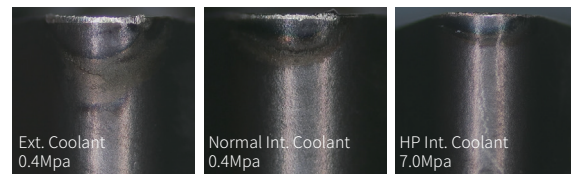

Cutting parameters: $V_c=90$ m/min, $f=0.12$ mm/rev $a_p=0.4$ mm, wet
Material: Inconel718
Insert type: CNMG120408 Ext. turning

Product list

C type Holder

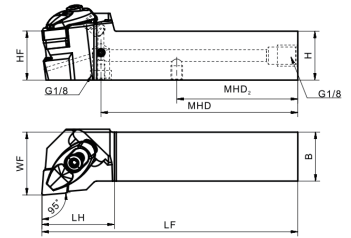
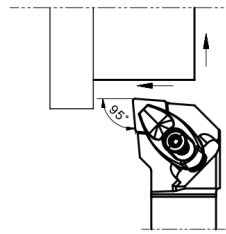
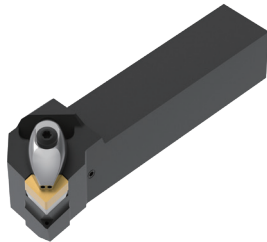

Tool holder	Size (mm)									Space Parts										Gage Insert
	H	HF	B	LF	LH	WF	MHD	MHD ₂	Re	Shim	Shim screw	Wrench	Clamp	Clamp screw	Wrench	Spring	Sealing ring	Large threaded plug	Small threaded plug	
DCLNR 2020X-12JT	20	20	20	115	36.8	25	85	46.5	0.8	S-DCN1204812-12	SH060103	LT-H4 LT-H3 LT-H5	JDN18-U2N00	CP050210	FT-TP15	YAO.60-6.30-11.7-4	SR-C074012	PL-G1/8100	PL-060060	CN**1204**
DCLNL 2020X-12JT																				
DCLNR 2525X-12JT	25	25	25	130	32	100	61.5													
DCLNL 2525X-12JT																				

D type Holder

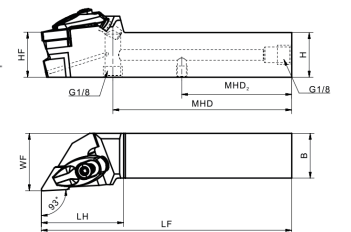
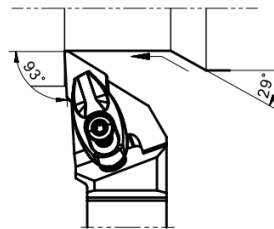

Tool holder	Size (mm)									Space Parts										Gage Insert
	H	HF	B	LF	LH	WF	MHD	MHD ₂	Re	Shim	Shim screw	Wrench	Clamp	Clamp screw	Wrench	Spring	Sealing ring	Large threaded plug	Small threaded plug	
DDJNR 2020X-1506JT	20	20	20	125	45	25	85	46.5	0.8	S-DDN1504812-11	SH060103	LT-H4 LT-H3 LT-H5	JDN18-U2R18	CP050210	FT-TP15	YAO.60-6.30-11.7-4	SR-C074012	PL-G1/8100	PL-060060	DN**1506**
DDJNL 2020X-1506JT													JDN18-U2L18							
DDJNR 2525X-1506JT	25	25	25	140	46	32	100	61.5	JDN18-U2R18											
DDJNL 2525X-1506JT									JDN18-U2L18											
DDJNR 2020X-1504JT	20	20	20	125	45	25	85	46.5	JDN18-U2R18											
DDJNL 2020X-1504JT									JDN18-U2L18											
DDJNR 2525X-1504JT	25	25	25	140	46	32	100	61.5	JDN18-U2R18											
DDJNL 2525X-1504JT									JDN18-U2L18											

Product list

T type Holder

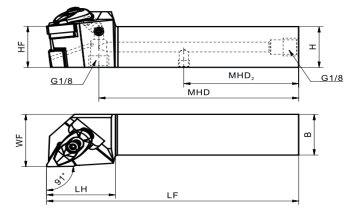
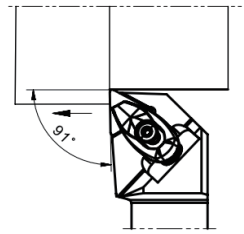
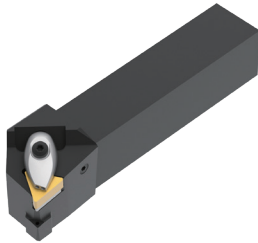

Tool holder	Size (mm)									Space Parts										Gage Insert
	H	HF	B	LF	LH	WF	MHD	MHD ₂	Re	Shim	Shim screw	Wrench	Clamp	Clamp screw	Wrench	Spring	Sealing ring	Large threaded plug	Small threaded plug	
DTGNR 2020X-16JT	20	20	20	120	35.8	25	93.5	46.5	0.8	S-DTNI603208	SH050085	LT-H3 LT-H5	JDN15-U2L20	CP040170	FT-TP09	YAO60-5.00-8-5	SR-C074012	PL-G1/8100	PL-060060	TN**1604**
DTGNL 2020X-16JT													JDN15-U2R20							
DTGNR 2525X-16JT	25	25	25	135	37	32	107	61.5					JDN15-U2L20							
DTGNL 2525X-16JT													JDN15-U2R20							

V style with 47° relief angle

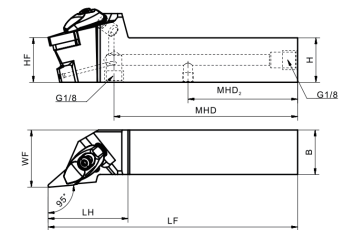
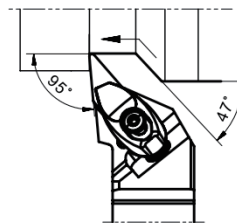

Tool holder	Size (mm)									Space Parts										Gage Insert
	H	HF	B	LF	LH	WF	MHD	MHD ₂	Re	Shim	Shim screw	Wrench	Clamp	Clamp screw	Wrench	Spring	Sealing ring	Large threaded plug	Small threaded plug	
DVLNR 2020X-16JT	20	20	20	125	42.8	25	88	46.5	0.8	S-DVNI603212	SH050085	LT-H3 LT-H5	JDN15-U2L20-VN16	CP040170	FT-TP09	YAO60-5.00-8-5	SR-C074012	PL-G1/8100	PL-060060	VN**1604**
DVLNL 2020X-16JT													JDN15-U2R20-VN16							
DVLNR 2525X-16JT	25	25	25	140	44.8	32	103	61.5					JDN15-U2L20-VN16							
DVLNL 2525X-16JT													JDN15-U2R20-VN16							

Product list

V style with 25° relief angle

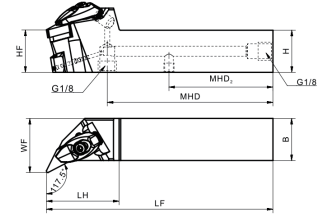
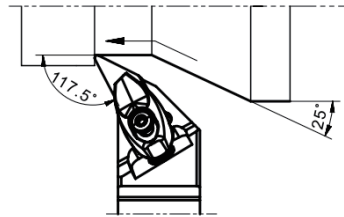
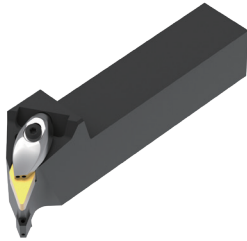

Tool holder	Size (mm)									Space Parts										Gage Insert
	H	HF	B	LF	LH	WF	MHD	MHD ₂	Re	Shim	Shim screw	Wrench	Clamp	Clamp screw	Wrench	Spring	Sealing ring	Large threaded plug	Small threaded plug	
DVPNR 2020X-16JT	20	20	20	118	43	25	81	46.5	0.8	S-DVN1603212	SH050085	LT-H3 LT-H5	JDN15-U2R20-VN16	CP040170	FT-TP09	YAO.60-5.00-8-5	SR-C074012	PL-G1/8100	PL-060060	VN**1604**
DVPNL 2020X-16JT													JDN15-U2L20-VN16							
DVPNR 2525X-16JT	25	25	25	134	32	98	61.5	0.8	S-DVN1603212	SH050085	LT-H3 LT-H5	JDN15-U2R20-VN16	CP040170	FT-TP09	YAO.60-5.00-8-5	SR-C074012	PL-G1/8100	PL-060060	VN**1604**	
DVPNL 2525X-16JT												JDN15-U2L20-VN16								

V style with 70° relief angle

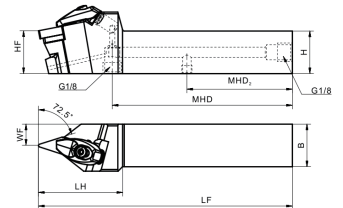
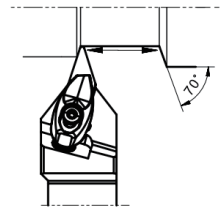
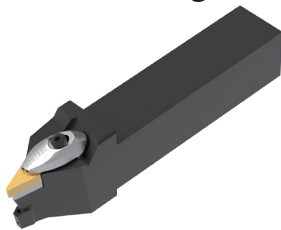

Tool holder	Size (mm)									Space Parts										Gage Insert
	H	HF	B	LF	LH	WF	MHD	MHD ₂	Re	Shim	Shim screw	Wrench	Clamp	Clamp screw	Wrench	Spring	Sealing ring	Large threaded plug	Small threaded plug	
DVVNN 2020X-16JT	20	20	20	130	49	10	87	46.5	0.8	S-DVN1603212	SH050085	LT-H3 LT-H5	JDN15-U2R20-VN16	CP040170	FT-TP09	YAO.60-5.00-8-5	SR-C074012	PL-G1/8100	PL-060060	VN**1604**
DVVNN 2525X-16JT													JDN15-U2R20-VN16							

Product list

W type Holder

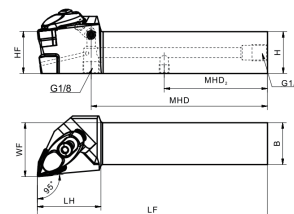
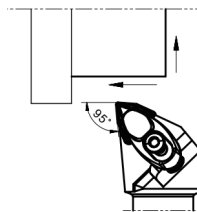
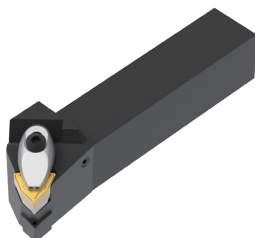

Tool holder	Size (mm)										Space Parts										Gage Insert
	H	HF	B	LF	LH	WF	MHD	MHD ₂	Re	Shim	Shim screw	Wrench	Clamp	Clamp screw	Wrench	Spring	Sealing ring	Large threaded plug	Small threaded plug		
DWLNLR 2020X-08JT	20	20	20	120	37.8	25	88	46.5	0.8	S-DWIN0804812-11	SH060103	LT-H4 LT-H3 LT-H5	JDN18-U2N00	CP050210	FT-TP15	YB0.70-6.50-12.7-5	SR-C074012	PL-G1/8100	PL-060060	WN**0804**	
DWLNLR 2020X-08JT																					
DWLNLR 2525X-08JT	25	25	25	137	38	32	105	61.5													
DWLNLR 2525X-08JT																					

Ext. Grooving and Cut-off HP Coolant Holder

With two direction accurate HP coolant supply can significant improve chip-breaking and tool life as well as stable machining.

Structure Design

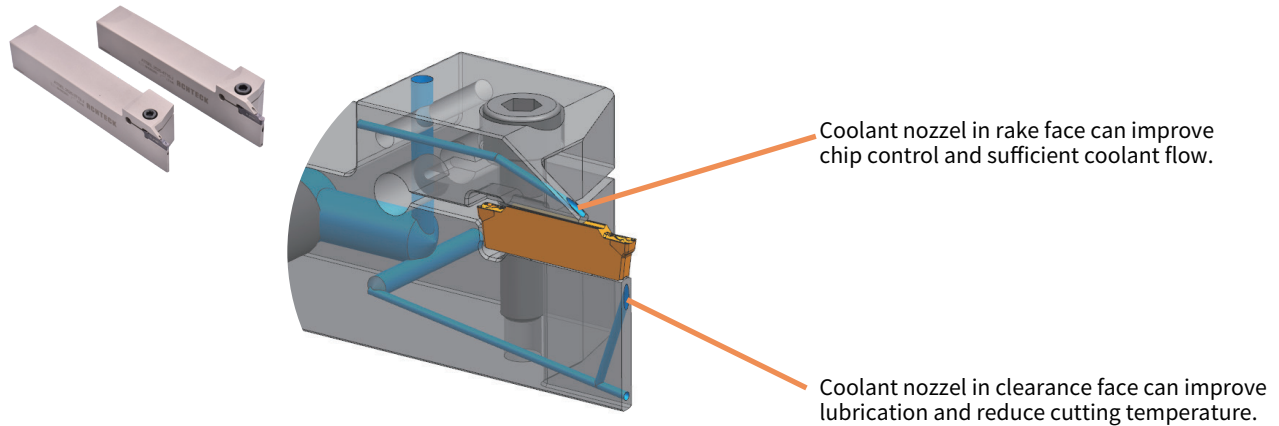

Cutting Performance

Wear Resistance Comparison

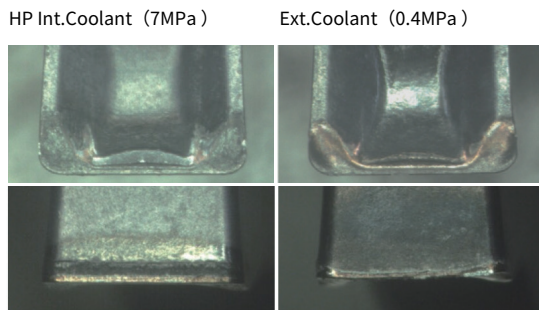

Cutting parameters: $V_c=200$ m/min, $f=0.2$ mm/rev, $a_p=10$ mm, Wet Material: 4340
 Insert: ACD 202-CH AP301U Ext. Grooving

Chip-breaking Comparison

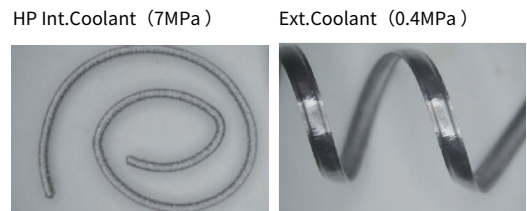

Cutting parameters: $V_c=200$ m/min, $f=0.12$ mm/rev, $a_p=10$ mm, Wet Material: 4340
 Insert: ACD 202-CH AP301U Ext. Grooving

Productivity Comparison

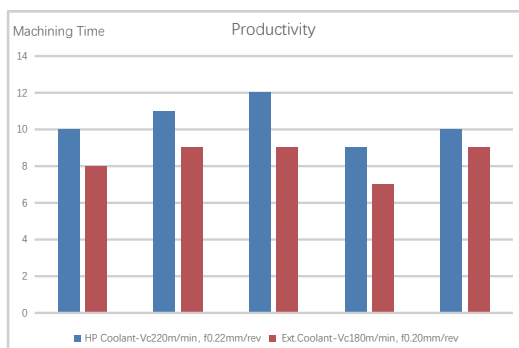

HP Int.Coolant Holder— ATSER 2020-2T12-J
 Cutting Parameter: $V_c=220$ m/min, $f=0.22$ mm/rev, $a_p=10$ mm, Wet Material: 4340
 Inserts: ACD 202-CH AP301U
 Ext. Grooving, Machining time per slot: 20s

Conventional Ext.Coolant Holer — ATSER 2020-2T12
 Cutting Parameter: $V_c=180$ m/min, $f=0.2$ mm/rev, $a_p=10$ mm, Wet Material: 4340
 Inserts: ACD 202-CH AP301U
 Ext. Grooving, Machining time per slot: 22s

♦ Geometry Application Recommendation

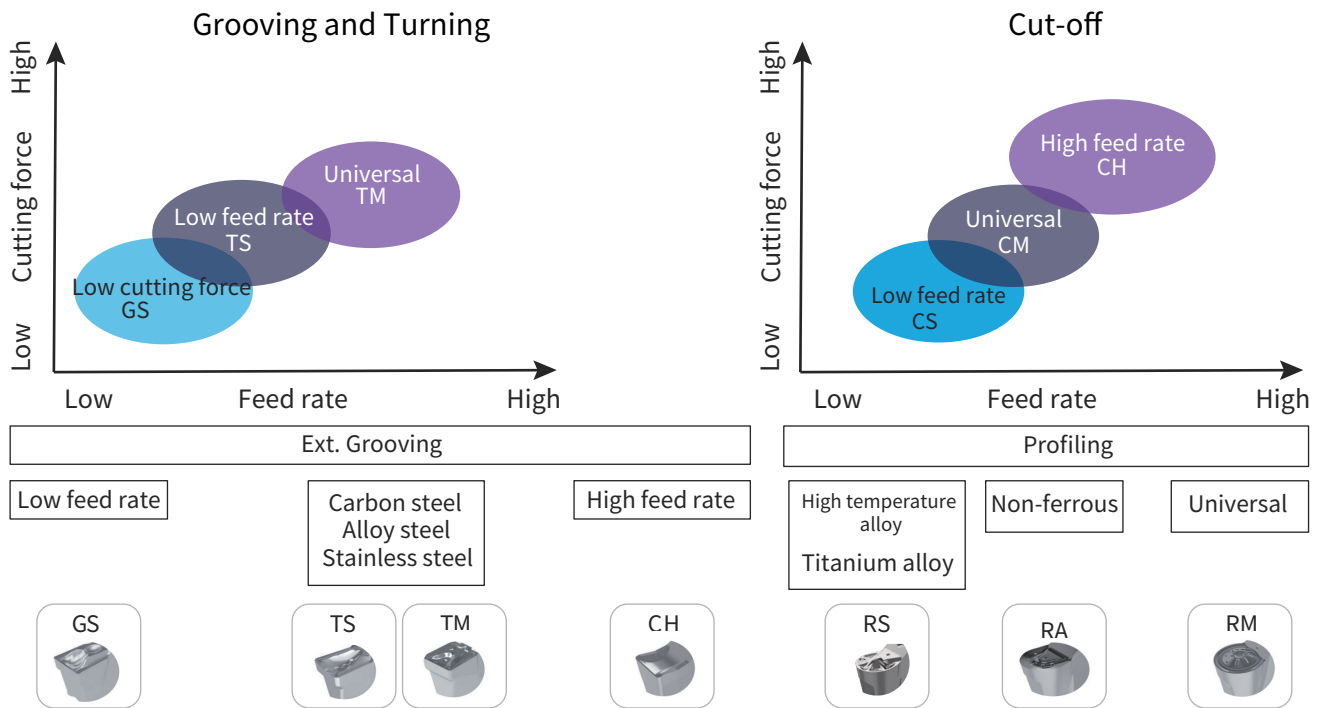

♦ Assembly of HP accessory

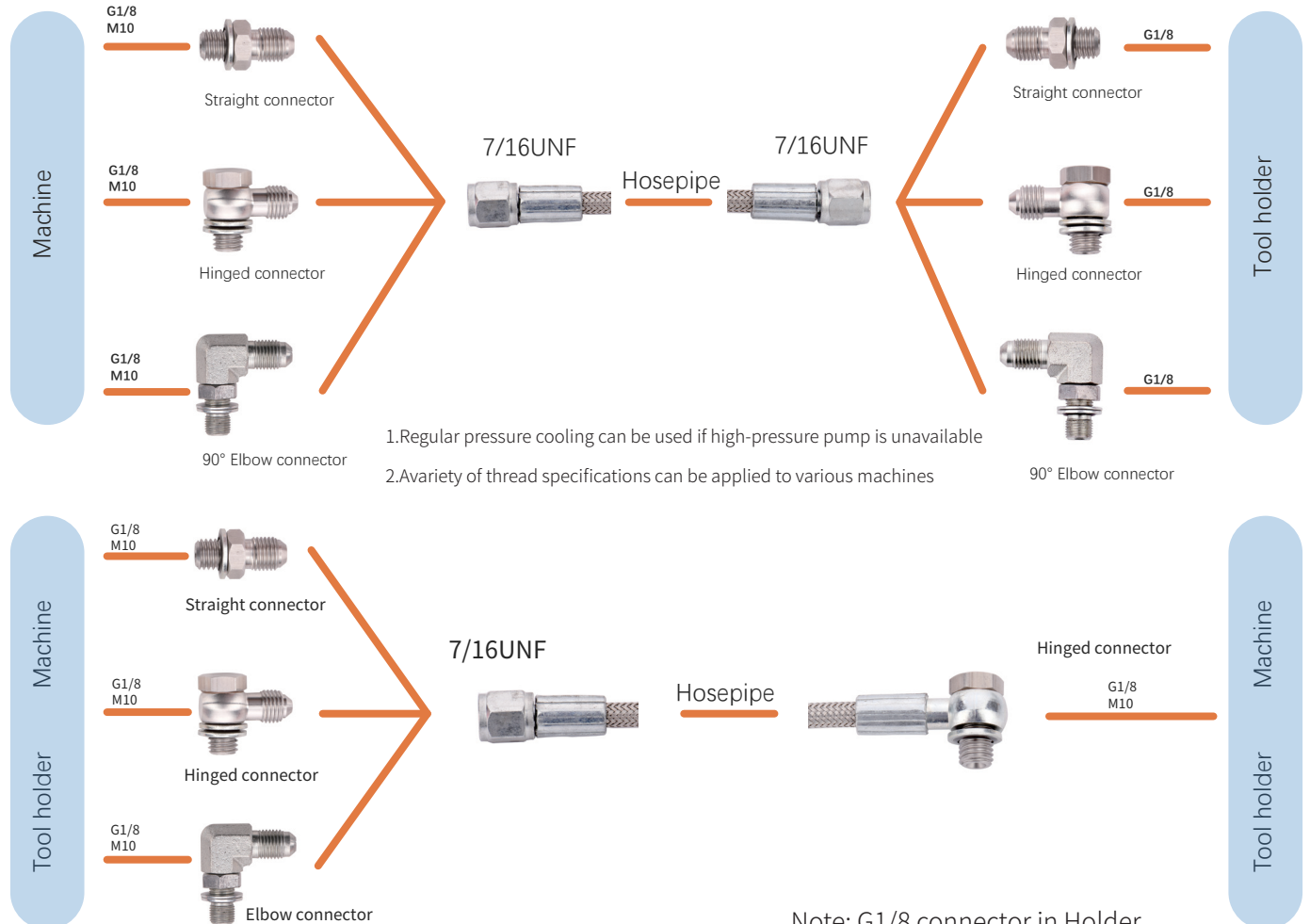

Product List

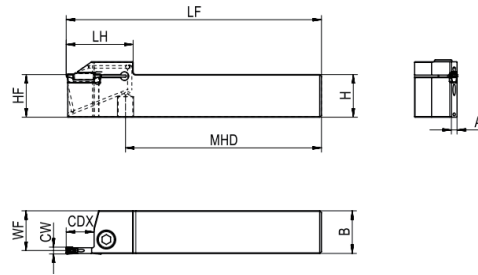
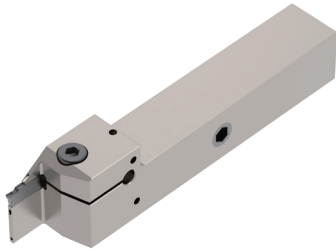

Groove Width	Type	Size									Space Parts			Gage Insert	
		H	HF	B	LF	LH	WF	CDX	MHD	CW	Fastening screw	Wrench	Plug screw		
2mm	ATSER 2020-2T12-J	20	20	20	125	37	19.1	12	73	2	SH050200	LT-H4	PL-G1/8080	ACD/ACS/ATD	
	ATSEL 2020-2T12-J														
	ATSER 2525-2T12-J	25	25	25	150	39	24.1		115.5	3			SH050250		G1/8080
	ATSEL 2525-2T12-J														
3mm	ATSER 2020-3T12-J	20	20	20	125	37	18.8	73	3	SH050200	PL-G1/8080				
	ATSEL 2020-3T12-J														
	ATSER 2525-3T12-J	25	25	25	150	39	24.1	115.5	SH050250	G1/8080					
ATSEL 2525-3T12-J															
4mm	ATSER 2020-4T10-J	20	20	20	125	37	18.3	10	73	4	SH060200	LT-H5	PL-G1/8080		
	ATSEL 2020-4T10-J														
	ATSER 2525-4T15-J	25	25	25	150	39	23.3	15	115.5	SH060250	G1/8080				
	ATSEL 2525-4T15-J														
5mm	ATSER 2525-5T20-J	25	25	25	150	45	22.8	20	111	5	SH080250	LT-H6	G1/8080		
	ATSEL 2525-5T20-J														
6mm	ATSER 2525-6T20-J	25	25	25	150	52	22.3	25	120.5	6	SH080250	LT-H6	G1/8080		
	ATSEL 2525-6T20-J														
8mm	ATSER 2525-8T25-J	25	25	25	150	58	21.9	25	115	8	SH080250	LT-H6	G1/8080		
	ATSEL 2525-8T25-J														

Accessories list

Name	Shape	Type	Stock	Screw specification
				Tool holder/machine connection side
Straight connector		JN 7/16-M10	●	M10
Hinged connector		JH 7/16-G1/8	●	G1/8
		JH 7/16-M10	●	M10
Elbow connector		JC 7/16-G1/8	●	G1/8
		JC 7/16-M10	●	M10

Name	Shape	Type	Stock	Screw specification		length MM
				Tool holder/machine connection side	Wrench side	
Hosepipe		JT 7/16-7/16-200	●	7/16UNF	7/16UNF	200
		JT 7/16-7/16-250	●	7/16UNF	7/16UNF	250
		JT 7/16-G1/8-200	●	G1/8	7/16UNF	200
		JT 7/16-G1/8-250	●	G1/8	7/16UNF	250
		JT 7/16-M10-200	●	M10	7/16UNF	200
		JT 7/16-M10-250	●	M10	7/16UNF	250